

USO INTERNO

ORCHIDEA OSCURANTE

ORCHIDEA
oscurante

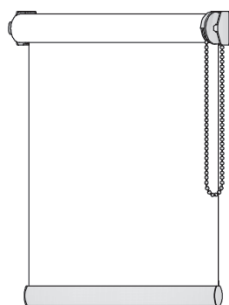

RULLO XS
A CATENA O MOLLA

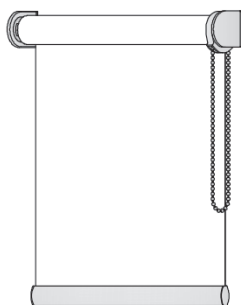

RULLO A CATENA
CON O SENZA
CASSONETTO

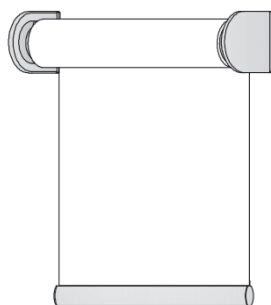

RULLO A MOTORE
CON O SENZA
CASSONETTO

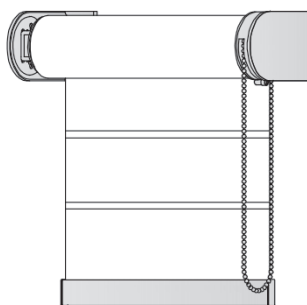

RULLO 70 XL
A CATENA O MOTORE
CON O SENZA
CASSONETTO

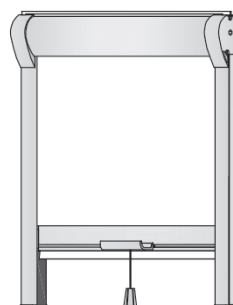

LOOK IN
A MOLLA O CATENA

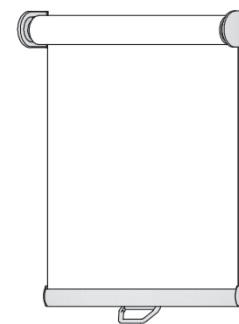

RULLO A MOLLA
CON O SENZA
CASSONETTO

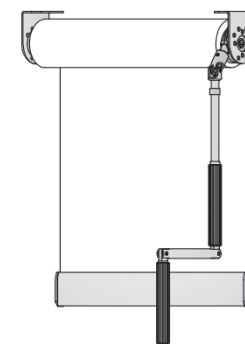

RULLO AD ARGANELLO
CON O SENZA
CASSONETTO

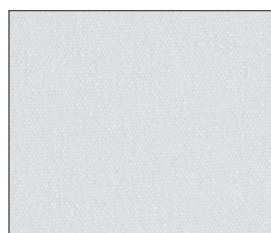
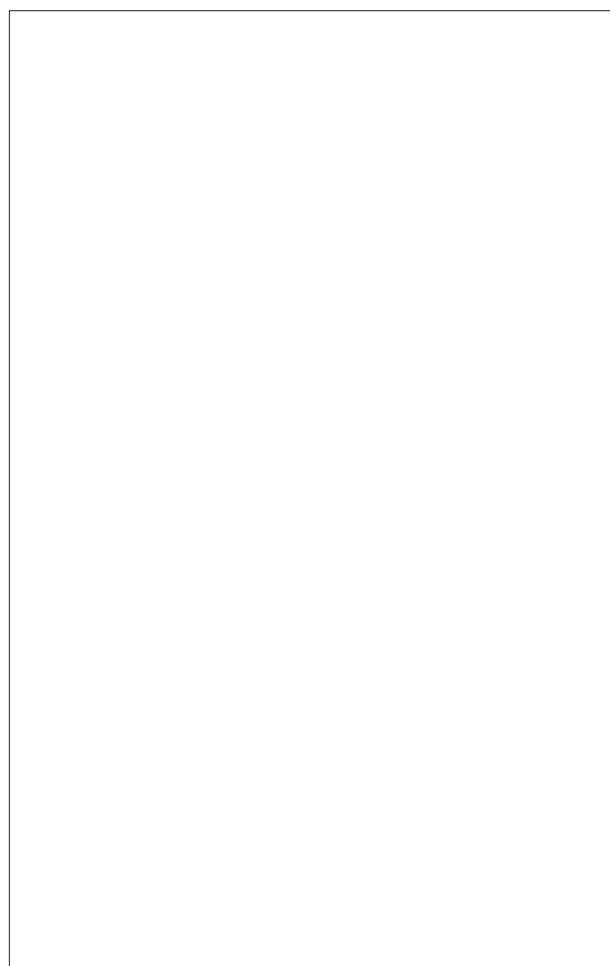

TV.003
Bianco ghiaccio

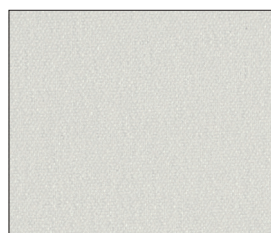

TV.024
Grigio chiaro

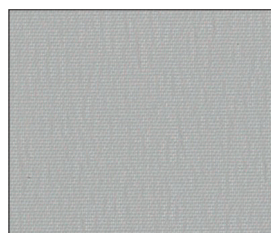

TV.013
Grigio

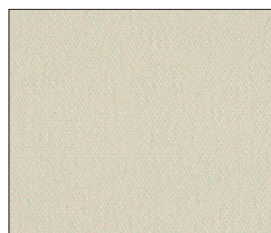

TV.007
Sabbia

Il lato colorato si intende vista interno stanza,
mentre quello bianco si intende vista esterna

ORCHIDEA OSCURANTE

DESCRIZIONE MATERIALE
Description of the material
Beschreibung des Materials

100 % POLIESTERE
100 % Polyester
100 % Polyester

PESO (g/mq.)
Weight (g/mq.)
Gewicht (g/mq.)

330 ± 10

SPESSORE (mm.)
Thickness (mm.)
Dicke (mm.)

0,30 ± 0,05

LARGHEZZA TESSUTO
Fabric width
Stoffbreite

205 cm.

COMPORAMENTO ALLA FIAMMA
Fire reaction
Feuerverhalten

IGNIFUGO CLASSE 1
Class 1 fire-retardant
Feuerhemmend Klasse 1



MANUTENZIONE
Maintenance
Wartung

PULIRE CON PANNINO UMIDO
Clean with damp cloth
Mit einem feuchten Lappen reinigen

STABILITÀ ALLA LUCE
Light fastness
Lichtechtheit

≥ 5 (UNI EN ISO 105-B02)

Corretta illuminazione
Guarantees proper lighting
Korrekte Beleuchtung



COMPORAMENTO ALLA LUCE
Behaviour to the light
Lichtreflektion

COLOR ± 2%	R **	T **	A **
TV.003	72	0	27
TV.007	65-72	0	28
TV.013	65-72	0	28
TV.024	72	0	27

** R= Riflessione; T= Trasmissione; A= Assorbimento

COMPORAMENTO AL CALORE
Behaviour to the heat
Warmereflektion

COLOR ± 2%	R **	T **	A **
TV.003	63	0	38
TV.007	63	0	38
TV.013	63	0	38
TV.024	63	0	38