

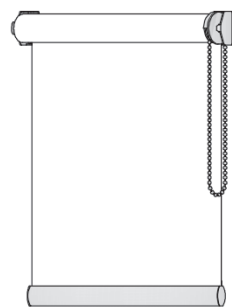

USO INTERNO

SOLTIS 99 FILTRANTE



RULLO XS
A CATENA O MOLLA

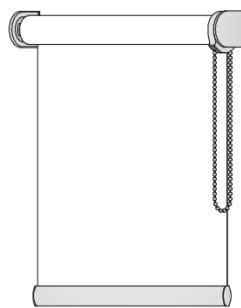

RULLO A CATENA
CON O SENZA
CASSONETTO

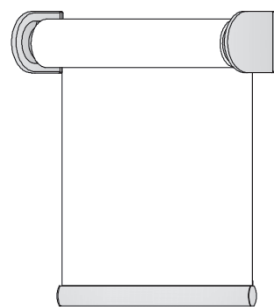

RULLO A MOTORE
CON O SENZA
CASSONETTO

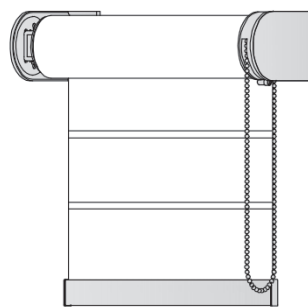

RULLO 70 XL
A CATENA O MOTORE
CON O SENZA
CASSONETTO

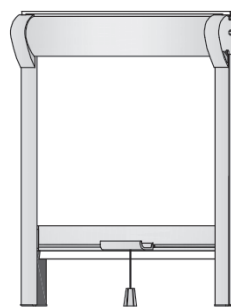

LOOK IN
A MOLLA O CATENA

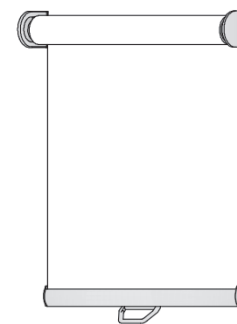

RULLO A MOLLA
CON O SENZA
CASSONETTO

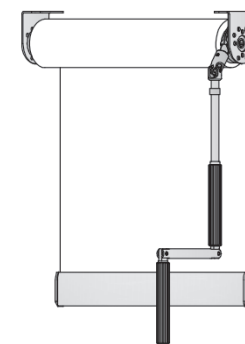

RULLO AD ARGANELLO
CON O SENZA
CASSONETTO

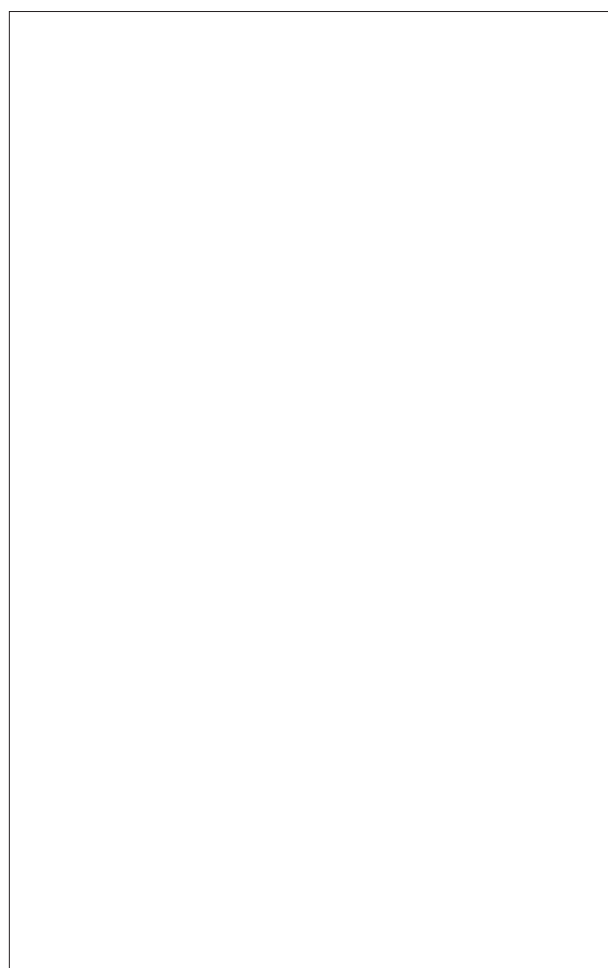

Il lato colorato si intende vista interno stanza,
mentre quello alluminio si intende vista esterna



GS.2055
Bianco



GS.2058
Grigio

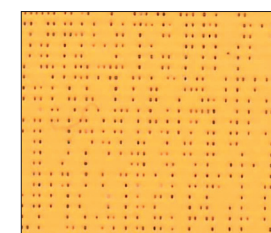

GS.50292
(solo in H.177 cm.)
Giallo



GS.50285
Beige



GS.2059
Alluminio

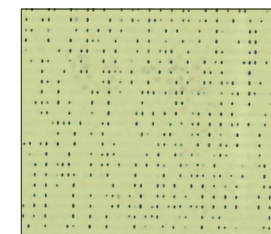

GS.50294
(solo in H.177 cm.)
Verde pastello

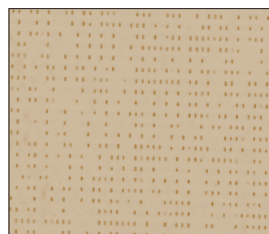

GS.50287
(solo in H.177 cm.)
Canapa



GS.2073
(solo in H.177 cm.)
Grigio scuro



GS.50300
(solo in H.177 cm.)
Verde acqua

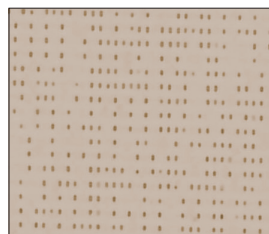

GS.50286
Sabbia



GS.2068
Antracite

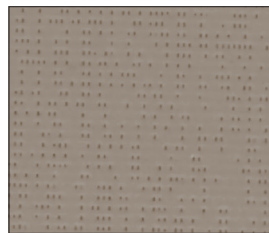

GS.50289
(solo in H.177 cm.)
Tortora

SOLTIS 99 FILTRANTE

DESCRIZIONE MATERIALE
Description of the material
Beschreibung des Materials

PES + PVC coating

COMPORAMENTO ALLA FIAMMA
Fire reaction
Feuerverhalten

IGNIFUGO CLASSE 1
Class 1 fire-retardant
Feuerhemmend Klasse 1



PESO (g/mq.)
Weight (g/mq.)
Gewicht (g/mq.)

290 ca.

MANUTENZIONE
Maintenance
Wartung

PULIRE CON PANNINO UMIDO
Clean with damp cloth
Mit einem feuchten Lappen reinigen

SPESSORE (mm.)
Thickness (mm.)
Dicke (mm.)

0,32 ca.

FATTORE DI APERTURA
Openess factor
Faktor von Öffnung

3%

LARGHEZZA TESSUTO
Fabric width
Stoffbreite

267 cm. - 177 cm.



Dati tessuto lato Alluminio (vista esterno stanza)

COMPORAMENTO AL CALORE
Behaviour to the heat
Warmereflektion

COLOR ± 2%	R **	T **	A **
GS.2055	50	9	41
GS.50285	47	9	44
GS.50287	46	7	47
GS.50286	44	7	49
GS.50289	42	6	52
GS.50292	45	11	44

** R= Riflessione; T= Trasmissione; A= Assorbimento

COMPORAMENTO AL CALORE
Behaviour to the heat
Warmereflektion

COLOR ± 2%	R **	T **	A **
GS.2058	47	7	46
GS.2059	47	4	49
GS.2073	40	4	56
GS.2068	36	3	61
GS.50294	47	6	47
GS.50300	48	5	47

Dati tessuto lato Colorato (vista interno stanza)

COMPORAMENTO AL CALORE
Behaviour to the heat
Warmereflektion

COLOR ± 2%	R **	T **	A **
GS.2055	69	9	22
GS.50285	60	9	31
GS.50287	48	7	45
GS.50286	45	7	48
GS.50289	30	6	64
GS.50292	52	11	37

** R= Riflessione; T= Trasmissione; A= Assorbimento

COMPORAMENTO AL CALORE
Behaviour to the heat
Warmereflektion

COLOR ± 2%	R **	T **	A **
GS.2058	45	7	48
GS.2059	47	4	49
GS.2073	25	4	71
GS.2068	9	3	88
GS.50294	54	6	40
GS.50300	41	5	54

La tonalità del colore delle tende potrà subire delle variazioni, pertanto l'azienda non si ritiene in alcun modo responsabile per questo inconveniente